



HAND TOOLS RANGE



Best Solution for Professional & Industrial users

Makita manufactures best-in-class industrial power tools for the professional user. With more than 100 years of experience in advanced motor design, Makita applies the latest innovation to engineer and manufacture the best power tools in the world. Makita Power Tools have more power and less weight, and are more compact and more efficient than any other.

Makita offers more solutions for the professional and industrial users and now offers a wide range of quality hand tools including wrenches, ratchets, sockets, pliers, screwdrivers, knife, measuring tape and many more.

Makita hands tools afford greater access in tight spaces and specifically designed to meet the diverse needs of all users.

We have categorized the hand tools in different sections from Wrenches to flashlight. Now you can choose your correct hand tools easily and quickly.



VIDEO

WRENCHES

- Adjustable wrench	05
- Locking adjustable wrench	05
- Adjustable wrench 11pcs set	06
- Flare nut wrench 5pcs. Set	07
- Double box wrench 5pcs. Set	07
- Combination wrench 9pcs. Set	08
- Double ratchet wrench 8pcs Set	08

PLIERS

- Box joint design Water pump pliers	10
- Water pump pliers	10

RATCHETS & SOCKETS

- 34pcs. Ratchet & Socket set	12
- 23pcs. Ratchet & Socket set	12
- Pass thru handle	13
- Pass thru handle with lock system	14
- Pass thru Extension bar	15
- Pass thru sockets	15
- Socket adapter	15
- 14pcs. Pass thru Socket Set	16
- 21pcs. Pass thru Socket Set	16
- 21pcs Ratchet handle with sockets & screwdriver bits	17

CUTTING TOOLS

- Aviation Snip	19
- Retractable Utility Knife	20
- Quick Change Folding Utility Knife	20
- Knife Blades 10pcs. Set	20
- Ratcheting tap & die	21
- 40pcs Ratcheting tap & die set	21

SCREWDRIVERS / HEX KEY

- Screw drivers	23
- Go through screwdrivers	24
- Shock driver	25
- Ratchet Screwdriver	26
- 11pcs Ratchet Screwdriver Pouch with Ratchet Handle	26
- Hex key set	27

HAMMER

- Smooth face claw hammer	28
---------------------------	----

MEASURING

- Tape Measures	30
- Tape Measure with Holder & safety lock	30

FLASHLIGHT

- L.E.D. pen light	31
--------------------	----

WRENCHES

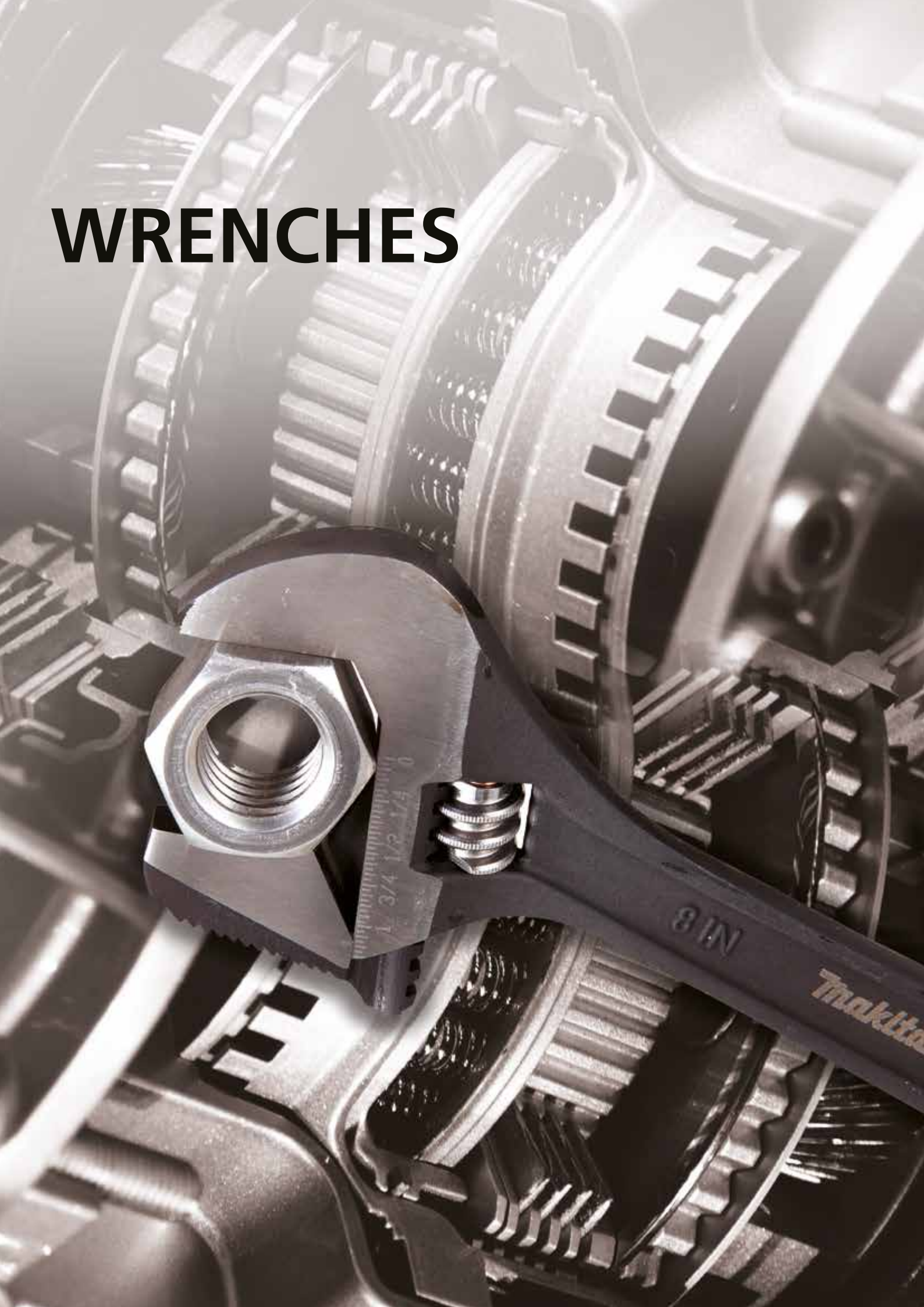

ADJUSTABLE WRENCH

Wide Capacity Jaw Allows Each Tool to Work with More Fastener Sizes

Hex jaw design reduces slippage and tightly grips bolt

Polished handle provide conspicuous brand mark.

Wider handle provide more comfort and less stress to the hand

Laser etched scale in both SAE/Metric

BLISTER PACK



MATERIAL	SIZE (LENGTH)	JAW	PART NO
Chrome Alloy Steel	6" / 150mm	0-29mm	B-65414
	8" / 200mm	0-36mm	B-65420
	10" / 250mm	0-38mm	B-65436
	12" / 300mm	0-43mm	B-65442

LOCKING ADJUSTABLE WRENCH

Jaw features grooved teeth for added grip

Delivers 2X gripping power on rounded fasteners

Laser etched scale in SAE and metric for easy adjustment

VIDEO



BLISTER PACK



MATERIAL	SIZES	MAX JAW SIZE	PART NO
Chrome Alloy Steel	10" / (250mm)	Ø35mm	B-65470

11PC PASS THRU ADJUSTABLE WRENCH SET

Sockets works on 6-point, 12-point, square, E-T, spline and partially rounded hex fasteners



Truly universal sockets fit both SAE and metric fasteners



Makita



Standard type



Can be used as pipe wrench

VIDEO



MATERIAL	SIZES	PART NO.
Chrome Alloy Steel	10pcs 3/8" socket: 3/8" (10mm), 7/16" (11mm), 15/32" (12mm), 1/2" (13mm), 9/16" (14mm), 19/32" (15mm), 5/8" (16mm), 11/16" (17mm), 23/32" (18mm), 3/4" (19mm) 1pc adjustable wrench: 200mm	B-65458

FLARE NUT WRENCH 5PCS. SET

Drop Forged of alloy steel for Durability
Full polish nickel chrome plated for long
tool life and easy cleaning

Offset Box ends spread turning
force throughout the entire fastener
head for a solid hold



Two open end of different
size gives your convenient
work

5PCS SET PACK



Large contact surface with
fastener reduces rounding
Suitable for aluminum, copper
and brass hexagonal fittings on
oil pipe

SIZES	PART NO
5pcs set (mm) 9x11, 10x12, 13x14, 15x17, 16x18mm	B-65545

DOUBLE BOX WRENCH 5PCS. SET

Drop Forged of alloy steel for Durability
Full polish nickel chrome plated for long
tool life and easy cleaning

75° Offset ends allow you to
work in tight spaces and offer
comfortable hand clearance

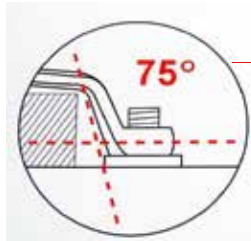

12 points of
contact for
dependable grip
and strength

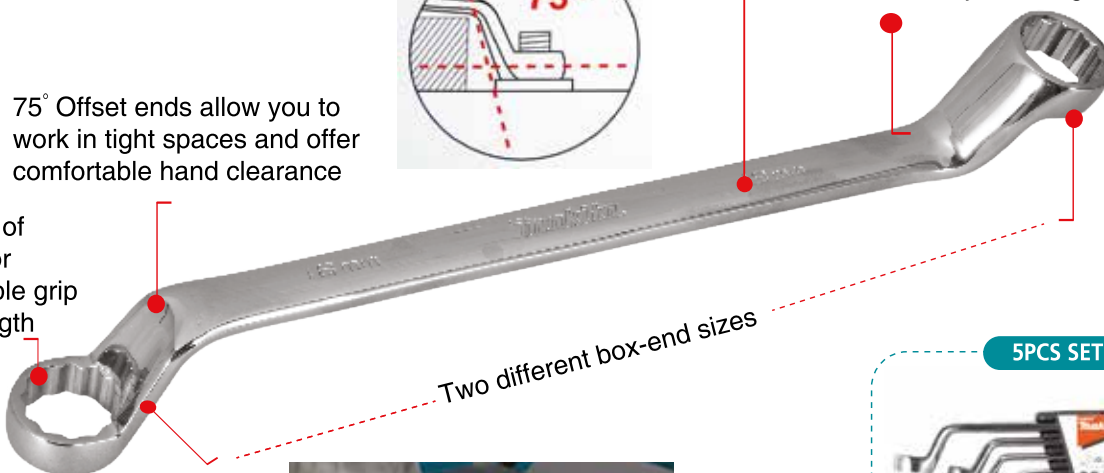

Two different box-end sizes

5PCS SET PACK



SIZE	PART NO
5pcs set (mm) Deep Offset 8x9, 10x11, 12x13, 14x15, 18x19mm	B-65551

COMBINATION WRENCHES 9PCS. SET

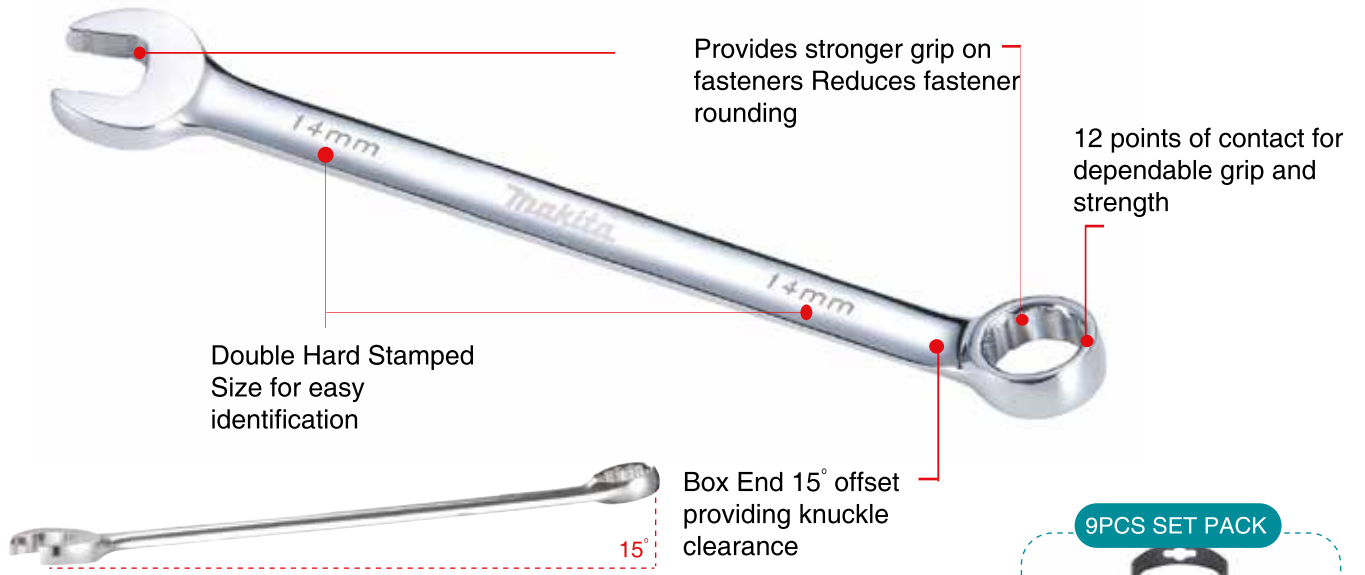

MATERIAL	SIZE	PART NO
Chrome Alloy Steel	8,10,12,13,14,15,16,17,18mm	B-65539

DOUBLE RATCHET WRENCH 8PCS SET

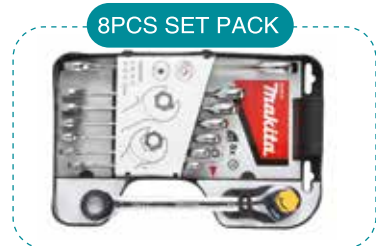
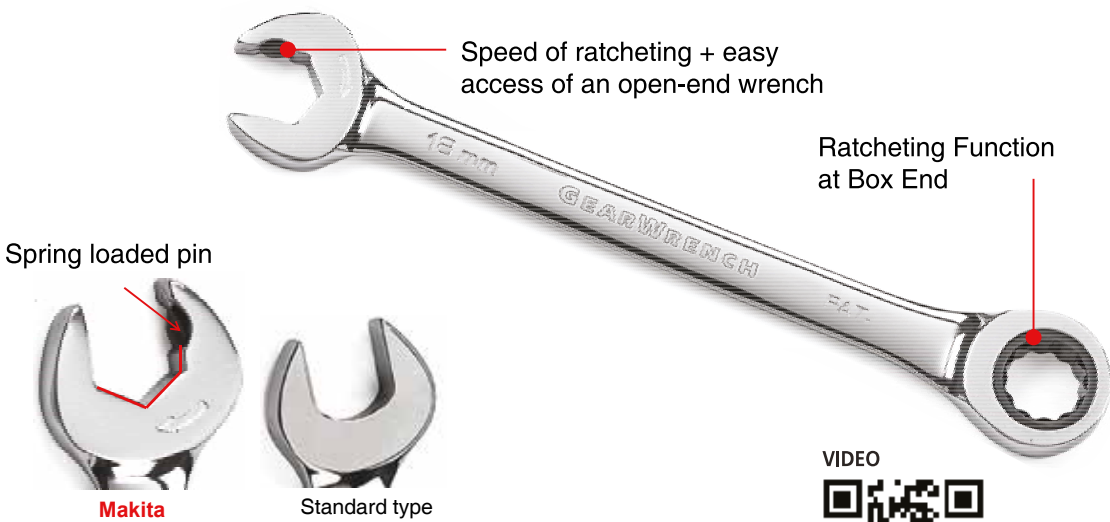

MATERIAL	SIZE	PART NO
Chrome Alloy Steel	8, 10, 12, 13, 14, 15, 17, 19mm	B-65523

PLIERS

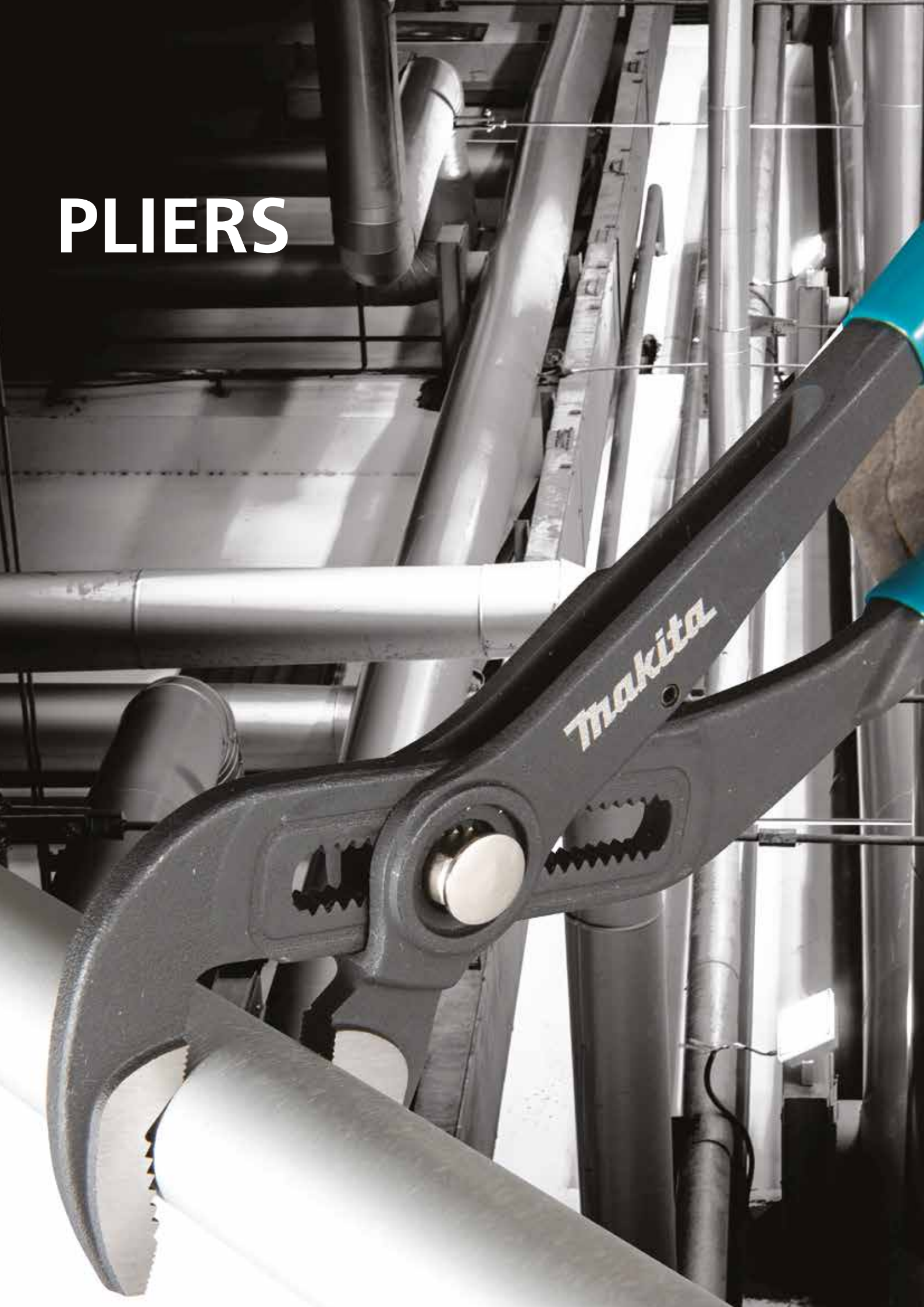

BOX-JOINT WATER PUMP PLIERS



Grips tightly
Makita



Standard type

Push button type adjustment

24 positions of fine adjustment for optimum adaptation

BLISTER PACK



Shape of gripping



Box-joint design for high stability

Makita
No unintentional shifting. Allows stable work.

MATERIAL	OVERALL LENGTH	MAX JAW SIZE	PART NO
Chrome Alloy Steel	7" (180mm)	37mm	B-65741
	9.5" (240mm)	49mm	B-65757
	12" (300mm)	68mm	B-65763

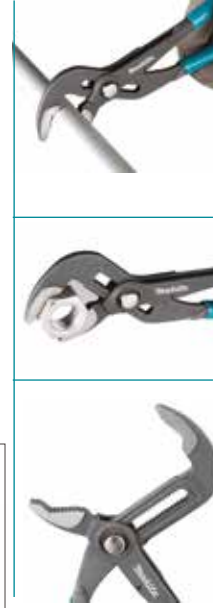

WATER PUMP PLIERS



Integrated Non-Marring Pipe Grip Prevents Damaging Object Surface Finish

"V" Jaws with Special Design and Induction Hardened Teeth Allow for Firmer Grip



NUT



PIPE

Grips tightly

BLISTER PACK



Exposed Steel Handle Tips Designed to Prevent Handle Pull-Off and Allow for Reaming and Tightening Tub Drains

MATERIAL	OVERALL LENGTH	MAX JAW SIZE	PART NO
Chrome Alloy Steel	10" / (250mm)	51mm	B-65486
	12" / (300mm)	76mm	B-65492



RATCHETS & SOCKETS



RATCHET & SOCKETS



84T
Push the button release

Mirror Finish

Blue and black ergo cushion grip, design for brand recognition and comfort.

Enclosed head design for extreme resistance to dirt infiltration

Low profile teardrop head, recessed switch lever allow access to tight spaces



Makita

Standard type

Provides a stronger grip on fasteners. Reduces fastener rounding

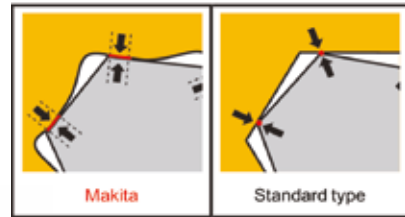

Makita

Standard type

Angled entry guides the socket on to the fastener



Large hard-stamped size on both sides for fast, easy identification



WITH CASE



WITH CASE



34PCS. 1/4" RATCHET & SOCKET SET

MATERIAL	TYPE	PART NO
Chrome Alloy Steel	1/4" SQ 84T Ratchet, 1/4" bit adapter,	B-65567
	1/4" SQ slide T bar	
	1/4" SQ socket : 4, 4.5, 5, 5.5, 6, 7, 8, 9, 10, 11, 12, 13mm	
	1/4" SQ deep socket : 5, 6, 7, 8, 9, 10, 11, 12, 13mm	
	1/4" SQ Extension bar : 3", 6"	
	T bit : T8, T10, T15, T20, T25, T27, T30, T40x25mm	

23PCS. 1/2" RATCHET & SOCKET SET

MATERIAL	TYPE	PART NO
Chrome Alloy Steel	1/2" SQ 84T Ratchet,	B-65589
	1/2" SQ adapter to 3/8" SQ,	
	1/2" SQ universal joint	
	1/2" SQ socket : 10, 11, 12, 13, 14, 15, 16, 17, 18,	
	19, 20, 21, 22, 23, 24, 27, 30, 32mm	
	1/2" SQ Extension bar : 5", 10"	

PASS THRU HANDLE

- Light weight
- Can work in tight space
- Fastens nuts on threaded rods easily and quickly

Pass-Thru handle & Socket System features the drive system that links drive tools and sockets. Allows you to fasten nuts on threaded rods easily and quickly

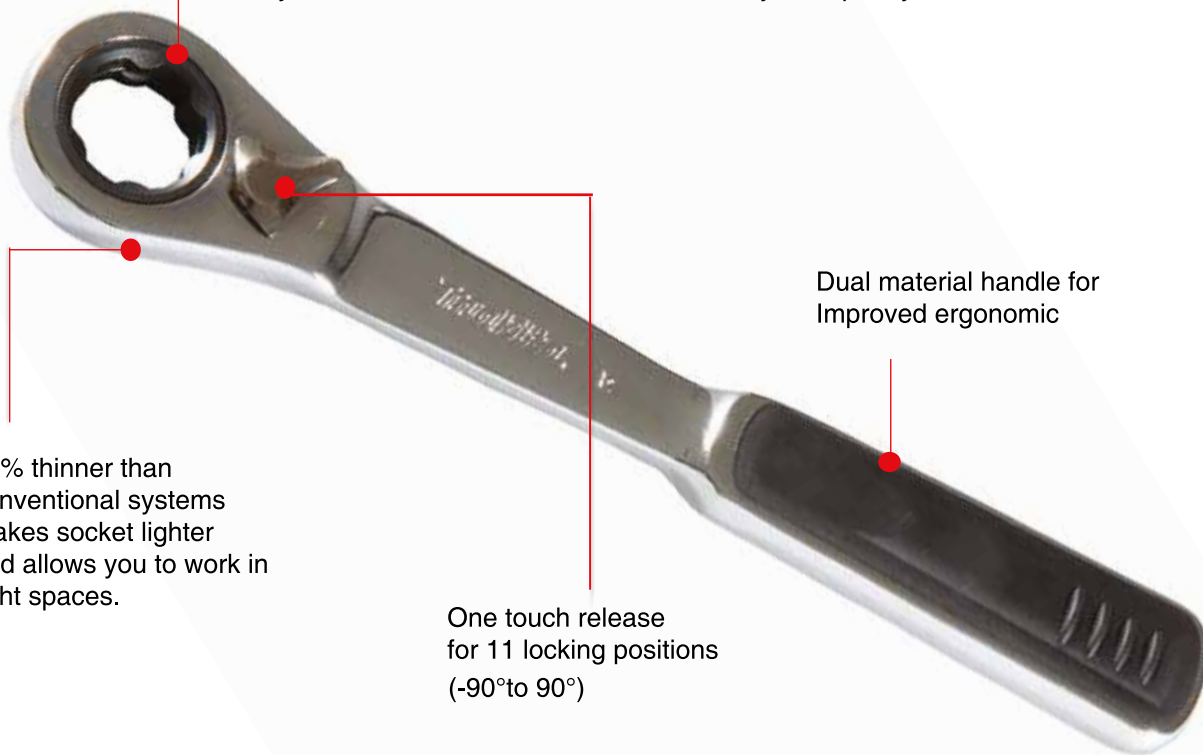

25% thinner than conventional systems makes socket lighter and allows you to work in tight spaces.

Dual material handle for Improved ergonomic

One touch release for 11 locking positions (-90° to 90°)

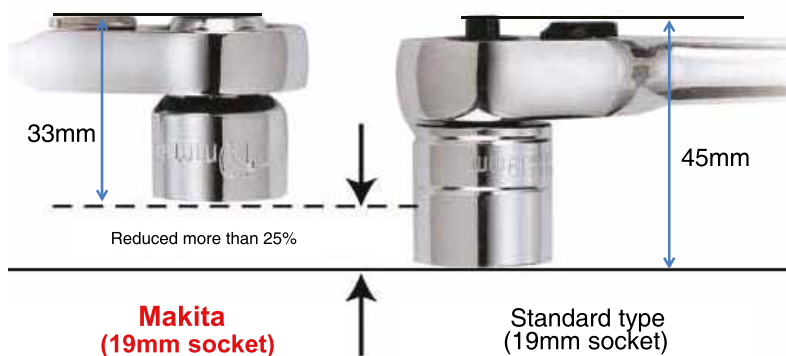

Makita
(19mm socket)

Standard type
(19mm socket)



VIDEO



MATERIAL	TYPE	PART NO
Chrome Alloy Steel	Pass thru handle Straight	B-65610

PASS THRU HANDLE WITH LOCK

- Light weight
- Can work in tight space
- Fasten nuts on threaded rods easily and quickly

Pass-Thru handle & Socket System features the drive system that links drive tools and sockets. Allows you to fasten nuts on threaded rods easily and quickly

25% thinner than conventional systems makes socket lighter and allows you to work in tight spaces.

Dual material handle for Improved ergonomic

One touch release for 11 locking positions (-90° to 90°)

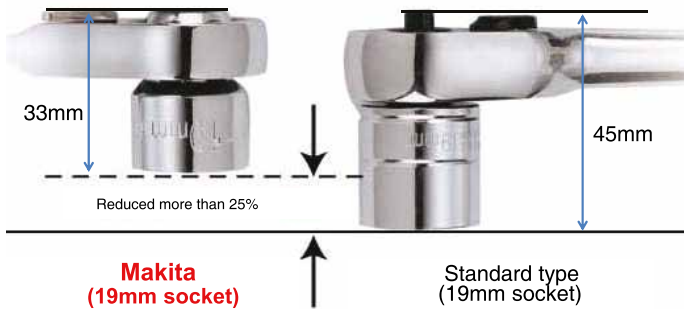

MATERIAL	TYPE	PART NO
Chrome Alloy Steel	Locking Flex Pass thru Handle	B-65626

PASS THRU SOCKET / EXTENSION BAR & SOCKET ADAPTER



PASS THRU SOCKET



BLISTER PACK

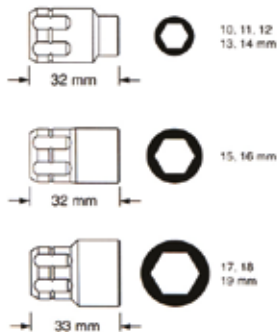

MATERIAL	SIZE	PART NO
Chrome Alloy Steel	10mm	B-65648
	11mm	B-65654
	12mm	B-65660
	13mm	B-65676
	14mm	B-65682
	15mm	B-65698
	16mm	B-65707
	17mm	B-65713
	18mm	B-65729
19mm	B-65735	

Extension bar

Allows you to fasten bolts or nuts In deep or tight spaces

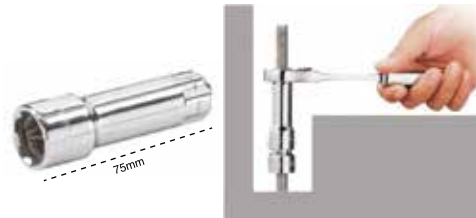

BLISTER PACK



MATERIAL	TYPE	PART NO
Chrome Alloy Steel	(75mm length)	B-65632

Socket adapter



Allows you to use Pass-Thru Ratchet with standard square drive sockets.



BLISTER PACK



MATERIAL	SIZE	PART NO
Chrome Alloy Steel	1/4"	B-65844

14PCS PASS THRU SOCKET SET

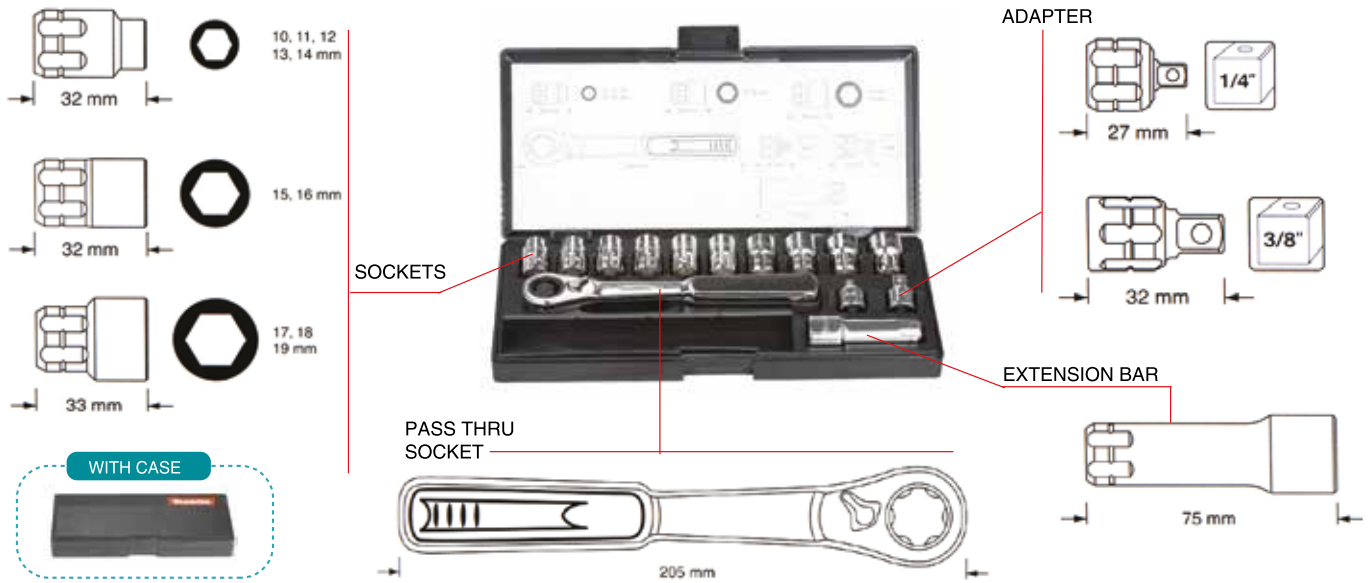

MATERIAL	TYPE	SIZE	PART NO
Chrome Alloy Steel	Pass thru Socket	10mm, 11mm, 12mm, 13mm, 14mm, 15mm, 16mm, 17mm, 18mm, 19mm	B-65595
	Socket adapter	1/4", 3/8"	
	Pass thru Extension bar	75mm	
	Ratchet handle	(Pass thru handle Straight)	

21PCS PASS THRU SOCKET SET



MATERIAL	TYPE	SIZE	PART NO
Chrome Alloy Steel	Pass thru Socket	10mm, 11mm, 12mm, 13mm, 14mm, 15mm, 16mm, 17mm, 18mm, 19mm, 3/8", 7/16", 1/2", 9/16", 5/8", 11/16", 3/4"	B-65604
	Socket adapter	1/4", 3/8"	
	Pass thru Extension bar	75mm	
	Ratchet handle	(Pass thru handle Straight)	

RATCHET HANDLE WITH SOCKETS & SCREW BITS

- 21pcs set which contains ratchet handle, socket and screw bits
- Ratchet handle is suitable in narrow space where hard to reach
- Screw bits are very easy to distinguish due to the color paint on bit head
- High quality set, packed in strong and sturdy box.



SOCKETS
5, 6, 8, 10, 12, 13mm

RATCHET HANDLE
100 mm

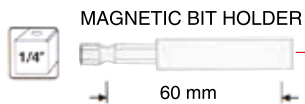

SCREW BITS

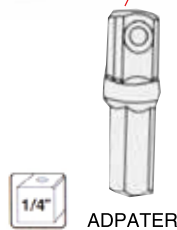

TYPE / SIZE /PCS	PART NO
3Pcs - Phillips bits: PH1, PH2, PH3 x 25mm	B-54081
2pcs - Slotted bits: SL0.8x5.5 x 25mm SL1.2x6.5 x 25mm	
3pcs - Torx bits T20,T25,T30 x 25mm	
2pcs - Pozi bits PZ1, PZ2 x 25mm	
2pcs - Hex bits H4, H6 x 25mm	
25mm Adapter - 1/4" Sand finished for hand	
6pcs - Socket Wrench with 6point for hand H5,H6,H8,H10,H12,H13	
1pc Magnetic Bit Holder - 60mm	
Mini Ratchet Wrench - 100mm	

CUTTING TOOLS



AVIATION SNIPS

- Non-slip dual material handle for comfort grip
- Cuts up to 1-2mm cold steel or 0.61mm stainless steel
- Induction hardened cutting edges



AVIATION SNIP CUTS RIGHT



BLISTER PACK



CAPACITY		PART NO
Cold-rolled steel	18ga (1.22mm)	B-65816
Stainless steel	23ga (0.61mm)	

AVIATION SNIP CUTS LEFT



BLISTER PACK



CAPACITY		PART NO
Cold-rolled steel	18ga (1.22mm)	B-65800
Stainless steel	23ga (0.61mm)	

AVIATION SNIP CUTS STRAIGHT



BLISTER PACK



CAPACITY		PART NO
Cold-rolled steel	18ga (1.22mm)	B-65791
Stainless steel	23ga (0.61mm)	

AVIATION SNIP BULLDOG



BLISTER PACK



CAPACITY		PART NO
Cold-rolled steel	16ga (1.63mm)	B-65822
Stainless steel	18ga (1.22mm)	

RETRACTABLE UTILITY KNIFE

Quick Blade Change For Easy And Fast Replacement



Accepts All Standard Type Utility Knife Blades



Safety string cutter with recessed blade

Blade storage for convenient access to new blades



PART NO

B-65785

QUICK CHANGE FOLDING UTILITY KNIFE

Folding Blade Safety, Compact



Quick Blade Change For Easy And Fast Replacement

Blade Safely Folds Into Handle For Compact Size And Easy Storage

Accepts All Standard Type Utility Knife Blades

Soft Grip Ergonomic Handle Design For Increased Comfort

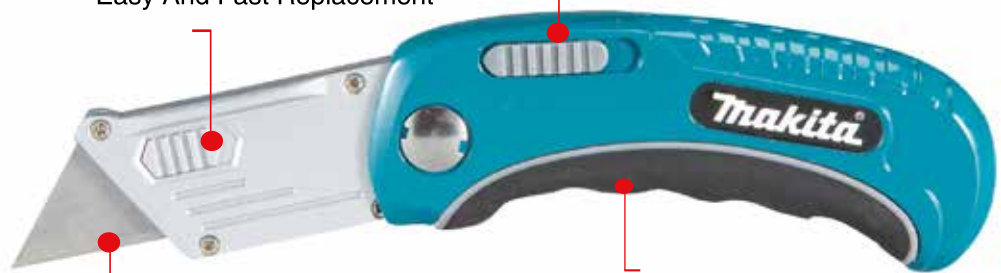

PART NO

B-65501

STANDARD BLADE SET



FOR QUICK CHANGE FOLDING UTILITY KNIFE AND RETRACTABLE UTILITY KNIFE

TYPE

Knife Blades 10pcs. Set

PART NO

B-65517

RATCHETING TAP & DIE

- Ratcheting Handle & adapter allow for easy back / forth movement required while cutting threads with either tap or die.
- Twist lock system ensures material stays properly aligned.
- Reversible lever with 5 degree ratcheting arc eliminates hand-over-hand turning.
- Ideal for working in tightly confined areas.
- Auto locking feature.



Ratchet Handle

Part No
B-65866

Tap Adapter
Cutting internal thread M3 to M12

Part No
B-65872

Die Adapter (Twist Lock)
Cleaning external thread M3 to M12

Part No
B-65888

40PCS RATCHETING TAP & DIE SET



MATERIAL	TYPE	SIZE	Part No
Chrome Alloy Steel	Small/Medium Ratcheting T Wrench	-	B-65838
	Small Tap Adapter	-	
	Medium Tap Adapter	-	
	Medium Hex Die Adapter	-	
	Screwdriver	-	
	Pitch Gauge	-	
	NC Hex Die	3mmx0.50, 3mmx0.60, 4mm x 0.70, 4mm x 0.75, 5mm x 0.80, 5mm x 0.90, 6mm x 1.00, 7mm x 1.00, 8mm x 1.25, 9mm x 1.25, 10mm x 1.50, 11mm x 1.50, 12mm x 1.75	
	NC Plug Tap	8mm x 1.25, 9mm x 1.25, 10mm x 1.50, 11mm x 1.50, 12mm x 1.75	
	NC Taper Tap	3mm x 0.50, 3mm x 0.60, 4mm x 0.70, 4mm x 0.75, 5mm x 0.80, 5mm x 0.90, 6mm x 1.00, 7mm x 1.00	
	NF Hex Die	9mm x 1.00, 10mm x 1.25, 12mm x 1.50	
NF Plug Tap	9mm x 1.00, 10mm x 1.25, 12mm x 1.50		
BSP Hex Die	1/8-28		
BSP Tap	1/8-28		

SCREWDRIVERS / HEX KEY

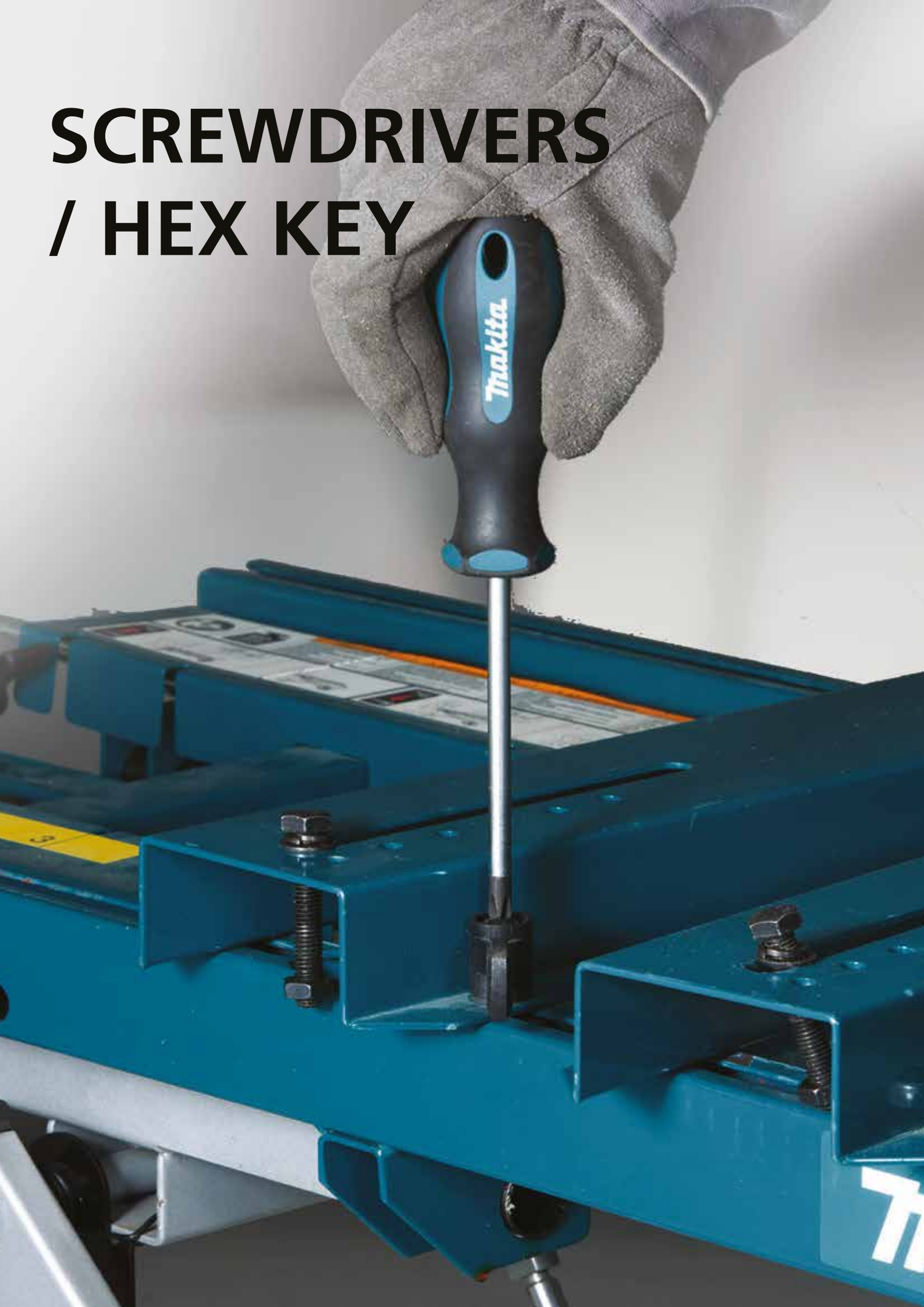

SCREWDRIVER STANDARD TYPE

- Ergonomic handle for best hand comfort.
- Anti-Slip and Oil Resistant Dual Material.



Clear mark of size and type in handle makes quick / easy identification

Precise size and Cr-V steel result in high torque strength and long life



Black magnetic tip for greater fastener control and guarantees a perfect fit every time

TYPE	SIZE	PART NO
PH1	(#1X100)	B-65903
PH2	(#2X100)	B-65919
PH3	(#3X150)	B-65931

TYPE	SIZE	PART NO
PZ1	(#1X80)	B-65947
PZ2	(#2X100)	B-65953
PZ3	(#3X150)	B-65969

TYPE	SIZE	PART NO
T10	(T10X100)	B-65975
T15	(T15X100)	B-65981
T20	(T20X100)	B-65997
T25	(T25X100)	B-66008
T30	(T30X100)	B-66014

TYPE	SIZE	PART NO
SL4.0	(4X100)	B-66020
SL5.5	(5.5X100)	B-66036
SL6.5	(6.5X125)	B-66042
SL8	(8X150)	B-66058

CLIP TYPE



SCREWDRIVER GO THROUGH TYPE

- Ergonomic handle for best hand comfort.
- Anti-Slip and Oil Resistant Dual Material.

Precise size and Cr-V steel result in high torque strength and long life

Black magnetic tip for greater fastener control and guarantees a perfect fit every time

With hex shaft which increases leverage and extra torque. fit any brand of wrench which can loosen tight screws easily



"Go-Through" construction provides greater striking force than traditional cap ends

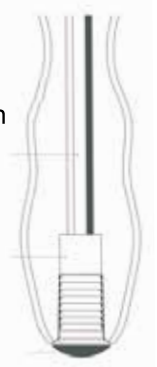

TYPE	SIZE	PART NO
PH1	(#1X75)	B-66064
PH2	(#2X100)	B-66070
PH3	(#3X150)	B-66086



TYPE	SIZE	PART NO
PZ1	(#1X75)	B-66092
PZ2	(#2X100)	B-66101
PZ3	(#3X150)	B-66117

SHOCK DRIVER

Makita shock driver is very useful tool which is able to be used as a regular hand driver and a shock driver when you work on the stripped screw.



This handy driver can remove the crushed or stripped screws which could not be loosened by electric tools. Applying the impact onto the handle generates a torque in the rotation direction, so the stripped screws can be removed.



HOW TO REMOVE

While applying force in the fastening direction, hold the grip securely.



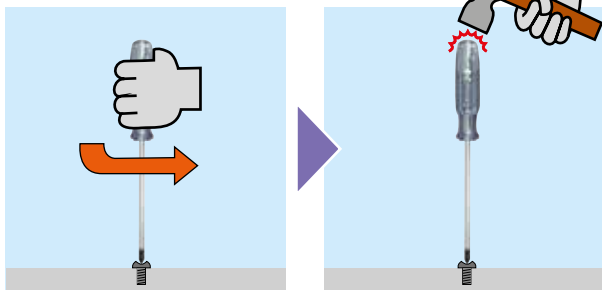

Apply strong impact with the hammer.

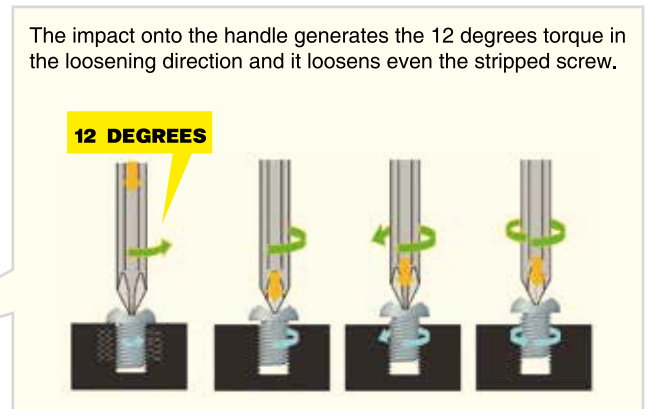

The impact onto the handle generates the 12 degrees torque in the loosening direction and it loosens even the stripped screw.



DIFFERENCE BETWEEN NORMAL DRIVER AND NEW SHOCK DRIVER

Item	Screw removal 	Stripped / Crushed screw removal 
MAKITA SHOCK DRIVER 	✓	✓
NORMAL SCREWDRIVER 	✓	✗

Please note: Our shock driver is intended for machine screws only. It is not suitable for screws into soft member such as wood screw or topping screw. Even after applying impact, the soft member might absorb the impact, or member itself might break. Also, it cannot be used for even machine screws that attach soft member such as aluminum, copper or thin board.

SIZE	LENGTH	PART NO
PH2	125mm	B-42438



RATCHET SCREWDRIVER

Ratchet handle with clockwise and anticlockwise function
Suitable for car maintenance, interior decoration, repair room, DIY etc.

rubber grains are applied in the handle for hard grip



clockwise and anticlockwise



PACK



With screw bit 25mm (PH2)x1pc.

Part No
D-58833

11 PCS RATCHET SCREWDRIVER WITH RACHET HANDLE

- The bag clings very well to the belt or the hem of the trouser pocket.
- The bits and holders are well fixed and easy to reach
- The handle can be attached to the case with an extra tab from the outside

PH2 screwdriver bit 25mm

Magnetic Extension bar 80mm

Magnetic quick change hex chuck

3pcs slotted bit

4pcs phillips bit

Non slip grip

Ratchet handle

BLISTER PACK



With Pouch

TYPE / SIZE / PCS	PART NO
7 pcs - 50mm screwdriver bits sizes 4 x Phillips bits: PH1, PH2, PH3 / 3 x Slotted bits: 5/32, 3/16, 1/4	P-90180
1pc - 25mm PH2 screwdriver bit	
1pc - 80mm Magnetic extension bar	
1pc - Magnetic quick change hex chuck	
1 pc - Ratchet Handle	

HEX KEY SET

Ball point for confined place and fastening in max 25° angle



With clip can be buckled to your pants and pick the size conveniently



Belt clip

BLISTER PACK



SIZE	PART NO
Hex key wrench 9pcs. set 1.5, 2, 2.5, 3, 4, 5, 6, 8, 10mm	B-65894



HAMMER



SMOOTH FACE CLAW HAMMER

- High quality monolithic cast steel material for excellent product durability
- The neck of the hammer is designed to help disperse the force transmitted back to the user's arm,
- High quality rubberized grip handle makes it very smooth and firm for the hand, also the air vents on the grip help users feel comfortable when holding the hammer,

Anti-Ring claw

Allows you to extract the nails which have been hammered by mistake



Forged one piece steel construction for increased strength and durability

Anti-vibration grip with air vent to minimize shock on hand



Smooth face



- Weight hammer head: 580g
- Total hammer weight: 960g

PART NO
B-65779



MEASURING



Makita measurement tape is highly durable and convenient to use. Normally when the scales are blurred or hook is lost, that would be the end of tape's life. This measuring tape is designed for professionals which has specially coated tape and hook protector's damper for absorbing shocks. This helps increasing durability of the measuring tape.

1. Special Coating

- "DURA COAT" for 5 times more durability
- "SILICA COAT" to make a note easily by a pencil



2. High durability of Hook

- Installed damper to absorb the shock on the hook
- Hook protector to reduce the shock on the hook
- Tightly fixed hook with "4rivets+protector"



3. Convenience

- 2-sided printing
- Hook with magnet
- Matte finish on tape reduces glare, making it easy to read in bright environments



Printed size
mm



Inch



mm/Inch



MEASURING



BLISTER PACK



Size	Length	Width	Part No.
mm	3.5m	16mm	B-57130



BLISTER PACK



Size	Length	Width	Part No.
mm/inch	5.5m/18ft	25mm/1"	B-57211
mm/inch	7.5m/25ft	25mm/1"	B-57227



BLISTER PACK



Size	Length	Width	Part No.
mm	10m	25mm	B-57168



BLISTER PACK



TAPE MEASURE WITH HOLDER & SAFETY CORD



Size	Length	Width	Part No.
mm	7.5m	25mm	B-57174

TAPE MEASURE WITH HOLDER & SAFETY CORD

The holder can be attached to waist belt and the measure can be attached/detached from a holder by single touch.



The measure and holder is tied by a safety cord so even if you drop the measure at high work place, safety cord avoids measure being fallen.



Attachable measure with a single touch. Press down the yellow lever and lift the measure.



FLASHLIGHT



LED PEN LIGHT

Compact, light and easy to carry
Compatible with AA battery
Application: Repair room, Car maintenance, DIY, etc



BLISTER PACK

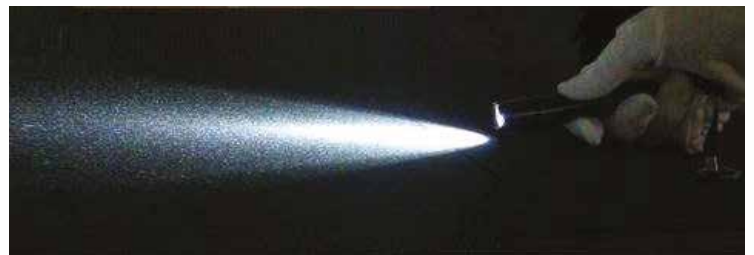

PART NO

D-58752

(AA BATTERY IS NOT INCLUDED)



MAKITA GULF FZE

P.O.Box 17133, Jebel Ali FZE (South), Dubai - U.A.E.
Tel. (971) 4 8860804 | Fax. (971) 4 8860805 | www.makita.ae
PART NO: (Z)000049 | PRINTED IN U.A.E: "V.19-1"

